

Exceptionally Accurate. Extremely Precise.

ZEISS Conquest V4
Riflescopes



Seeing beyond



New ZEISS Conquest V4 Riflescopes for 2020

NEW

Highly intuitive reticles, the Ballistic Stop™, and the all-new External Locking Windage Turret, combined with legendary ZEISS optics, create a superior system that ensures first shot impact on long-range targets – exactly where you want it.

ZEISS Conquest V4 Riflescopes

The Conquest V4 riflescopes are for hunters and shooters whose lifestyle and adventures involve traditional and long-range hunting, as well as shooting and long-range shooting. These riflescopes were designed as a lightweight, high-performance product line for various demanding hunting and shooting applications. They are by any standard best-in-class.



80 MOA Elevation Travel
with new rotation scale indicators.



Ballistic Stop™
An absolute and ultra-positive return to zero – every time.

Designed and Engineered in Germany

Absolute reliability to withstand the test of harsh recoil, extreme temperatures and abusive field conditions.

Proven 4x Zoom

A 4x zoom ratio provides a high level of versatility across a wide array of applications.

Side Parallax Adjustment and Reticle Illumination Control

Adjustable to ensure absolute best images and most accurate shooting solutions. 10-position rheostat-controlled illumination adjustment.

Second Focal Plane Reticle Options

Feature fine line subtensions to ensure minimum target coverage and maximum target visibility – with extreme precision.



Generous Eyepiece

Enables swift and accurate shot placement.

All-New External Locking Windage Turret

First-in-class External Locking Windage Turret (ELWT), with windage limiter, makes for easy, super-fast, repeatable, and secure windage adjustments.

External Turret with Ballistic Stop™

Solid, fast, tactile, and easy to manipulate turret, with Ballistic Stop™ and large range of adjustment.

Higher Definition Optics

Enhanced with T* (T Star) light transmission coatings and LotuTec protective lens coating, to produce 90% to-the-eye light transmission, with great low-light performance.

OPTICS:

T* T* Six-Layer Lens Multi-Coating



Capped Turret



Ballistic Stop

LotuTec®



External Turret



Multi-Turn Turret

90% 90% Light Transmission



External Locking Windage Turret



1/4 MOA

FEATURES:

2ND 2nd Focal Plane



Nitrogen Purged



30 mm Maintube

4x 4x Zoom



Illuminated



Waterproof up to 400 mbar



Lightweight



ZEISS Limited Lifetime Transferable Warranty and Five-Year No-Fault Policy

ZEISS Conquest V4 3-12x44

Higher Definition Optics
Ensure clearer and brighter images.



Capped Elevation Turret

Capped Windage Turret

Ideal zoom range. Designed for hunting. No-nonsense package.

The ZEISS Conquest V4 3-12x44 is the gateway to ZEISS riflescopes. It offers a highly versatile zoom range that is the model for hunting in most any environment around the globe. The compact design allows for easy mounting across an array of rifle platforms.

Second Focal Plane Reticle Non-Illuminated

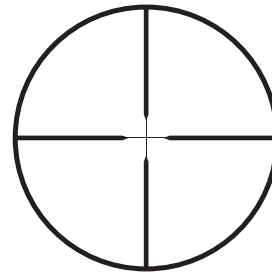

#20 Z-Plex

INTENDED APPLICATIONS



Predator / Varmint



Plains Game



Big Game



Long Range



Competition / Target Shooting



AVAILABLE KEY FEATURES



Capped Elevation Turret



Capped Windage Turret



ZEISS Conquest V4 3-12x56

Higher Definition Optics
Ensure clearer and brighter images.



Reticle Illumination
Confirm the exact point of aim in low-light conditions.

Capped Elevation Turret

Capped Windage Turret

Ideal zoom range. A light gathering phenomenon. Designed for hunting.

The 3-12x56 model is a mid-range magnification rifle scope that masters the light at twilight. It dominates hunting in thick timber and open farmland. The 3-12x56 is exceptional for light-starved hunting conditions and remains the leader in low-light performance.

Second Focal Plane Reticles

Non-illuminated

Illuminated

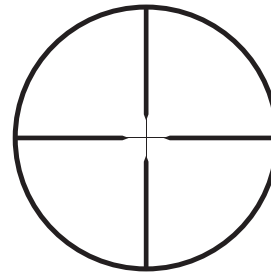

#20 Z-Plex

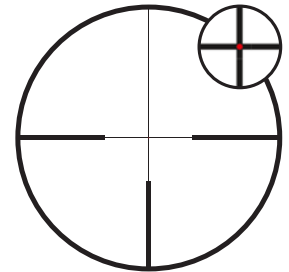

#60

INTENDED APPLICATIONS



Predator / Varmint



Plains Game



Big Game



Long Range



Competition / Target Shooting



AVAILABLE KEY FEATURES



Illuminated Reticle Options



Capped Elevation Turret



Capped Windage Turret



ZEISS Conquest V4 4-16x44

Higher Definition Optics
Ensure clearer and brighter images.

Side Parallax Adjustment
Adjust for utmost accuracy and best image quality.

Reticle Illumination
Confirm the exact point of aim in low-light conditions.



Ballistic Stop™
Easily identify and return to zero with authority and speed.

External Locking Windage Turret
Engage the target with extreme confidence.

Enhanced Engravings
Identify settings quickly from the shooting position.

Lightweight. Streamlined. Feature-rich.

The 4-16x44 model represents a highly versatile riflescope that is at home in the deer stand or while lying prone in the field taking those demanding long-range shots. Weight sensitive, compactly designed, and performance-oriented, the 4-16x44 is the perfect hunting rifle companion. Premium performance with premium features makes this riflescope an outstanding option for your next hunt.

INTENDED APPLICATIONS



Predator / Varmint



Plains Game



Big Game



Long Range



Competition / Target Shooting



AVAILABLE KEY FEATURES



Illuminated Reticle Options



External Elevation Turret with Ballistic Stop™



Capped Elevation Turret



External Locking Windage Turret with Windage Limiter



Capped Windage Turret



Side Parallax Adjustment



ZEISS Conquest V4 4-16x44

Key Features



External Elevation Turret

80 MOA elevation travel with new rotation scale indicators.



Ballistic Stop™

An absolute and ultra-positive return to zero – every time. Made of all-metal construction. No plastic. Select your zero, set the Ballistic Stop, and enjoy a lifetime of repeatability.



External Locking Windage Turret

First-in-class External Locking Windage Turret (ELWT), with windage limiter, makes for easy, super-fast, repeatable, and secure windage adjustments. Pull out to adjust. Push in to lock.



Side Parallax Adjustment and Reticle Illumination Control

Adjustable to ensure absolute best images and most accurate shooting solutions. 10-position rheostat-controlled illumination adjustment.

Second Focal Plane Reticles

Illuminated

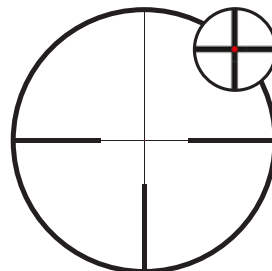

#60

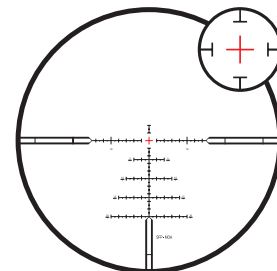

ZBi

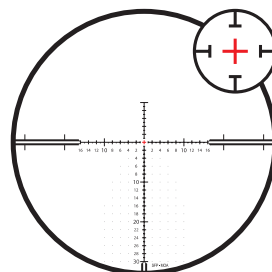

ZMOAi-T30

Non-Illuminated

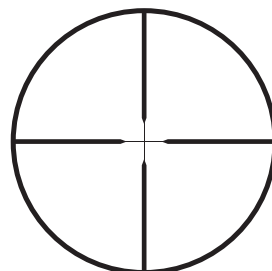

#20 Z-Plex

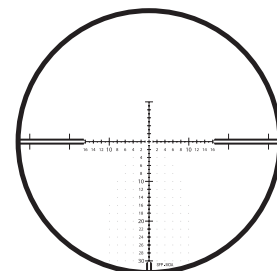

ZMOA-T30

ZEISS Conquest V4 4-16x50

Higher Definition Optics

Ensure clearer and brighter images.

Side Parallax Adjustment

Adjust for utmost accuracy and best image quality.

Reticle Illumination

Confirm the exact point of aim in low-light conditions.

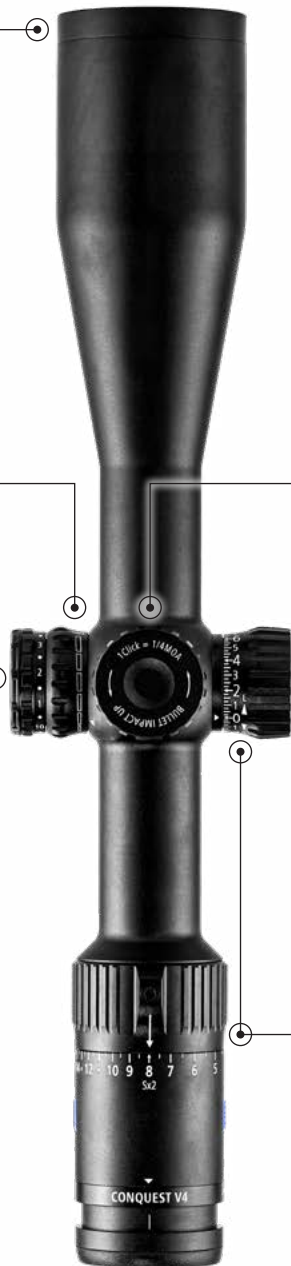

Ballistic Stop™

Easily identify and return to zero with authority and speed.

External Locking Windage Turret

Engage the target with extreme confidence.

Enhanced Engravings

Identify settings quickly from the shooting position.

Feature-rich. Bright. Versatile.

The 4-16x50 model could be the most ideal riflescope from the Conquest V4 family. The applications are nearly endless. It offers a near-perfect zoom range for hunting in dense woods and is equally up to the task of taking – and making – those tougher shots at greater distances. The low-light performance is unmatched in its class due to the 50 mm objective size. It's hard to envision a more diverse riflescope to tackle most any hunting and shooting task.

INTENDED APPLICATIONS



Predator / Varmint



Plains Game



Big Game



Long Range



Competition / Target Shooting



AVAILABLE KEY FEATURES



Illuminated Reticle Options



External Elevation Turret with Ballistic Stop™



Capped Elevation Turret



External Locking Windage Turret with Windage Limiter



Capped Windage Turret



Side Parallax Adjustment



ZEISS Conquest V4 4-16x50

Key Features



External Elevation Turret

80 MOA elevation travel with new rotation scale indicators.



Ballistic Stop™

An absolute and ultra-positive return to zero – every time. Made of all-metal construction. No plastic. Select your zero, set the Ballistic Stop, and enjoy a lifetime of repeatability.



External Locking Windage Turret

First-in-class External Locking Windage Turret (ELWT), with windage limiter, makes for easy, super-fast, repeatable, and secure windage adjustments. Pull out to adjust. Push in to lock.



Side Parallax Adjustment and Reticle Illumination Control

Adjustable to ensure absolute best images and most accurate shooting solutions. 10-position rheostat-controlled illumination adjustment.



Second Focal Plane Reticles

Illuminated

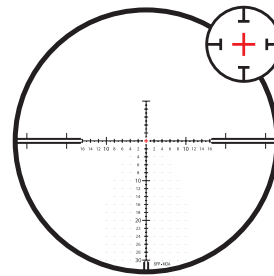

ZMOAi-T30

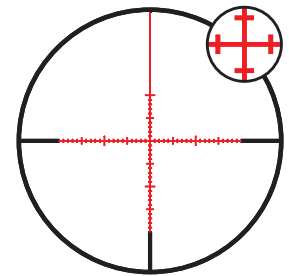

ZMOAi-1

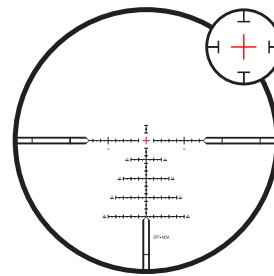

ZBi

Full reticle details on pages 20-32

ZEISS Conquest V4 6-24x50

Higher Definition Optics

Ensure clearer and brighter images.

Side Parallax Adjustment

Adjust for utmost accuracy and best image quality.

Reticle Illumination

Confirm the exact point of aim in low-light conditions.



Ballistic Stop™

Easily identify and return to zero with authority and speed.

External Locking Windage Turret

Engage the target with extreme confidence.

Enhanced Engravings

Identify settings quickly from the shooting position.

Powerful. Lightweight. Feature-rich.

The 6-24x50 model is a higher magnification riflescope that masters target identification. It is ideal for testing ammunition, load development, target shooting, and hunting, and it is exceptional for long-range hunting. The 6-24x50 provides exceptional performance and repeatable results down-range, and it represents the best of best-in-class.

INTENDED APPLICATIONS



Predator / Varmint



Plains Game



Big Game



Long Range



Competition / Target Shooting



AVAILABLE KEY FEATURES



Illuminated Reticle Options



External Elevation Turret with Ballistic Stop™



Capped Elevation Turret



External Locking Windage Turret with Windage Limiter



Capped Windage Turret



Side Parallax Adjustment



ZEISS Conquest V4 6-24x50

Key Features



External Elevation Turret

80 MOA elevation travel with new rotation scale indicators.



Ballistic Stop™

An absolute and ultra-positive return to zero – every time. Made of all-metal construction. No plastic. Select your zero, set the Ballistic Stop, and enjoy a lifetime of repeatability.



External Locking Windage Turret

First-in-class External Locking Windage Turret (ELWT), with windage limiter, makes for easy, super-fast, repeatable, and secure windage adjustments. Pull out to adjust. Push in to lock.



Side Parallax Adjustment and Reticle Illumination Control

Adjustable to ensure absolute best images and most accurate shooting solutions. 10-position rheostat-controlled illumination adjustment.

Second Focal Plane Reticles

Illuminated

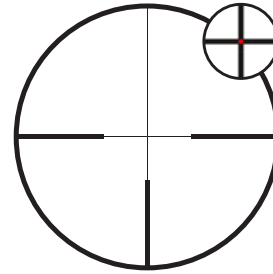

#60

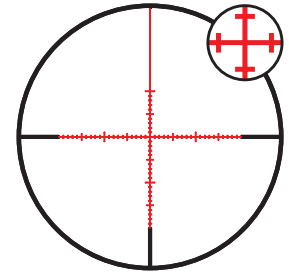

ZMOAi-1

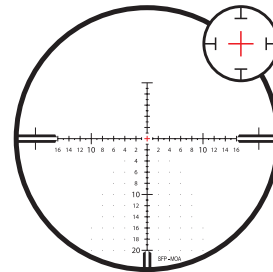

ZMOAi-T20

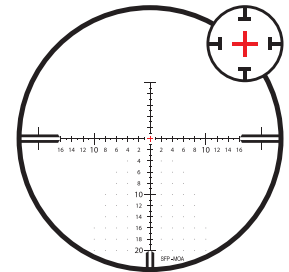

ZMOAi-20

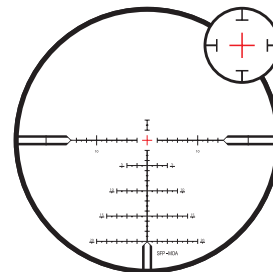

ZBi

Reticle Details and Applications

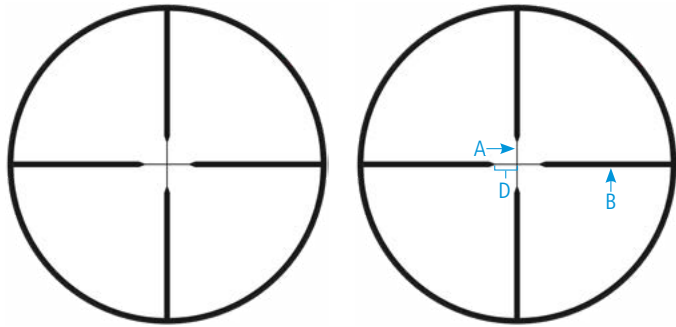

RETICLE TYPE

RETICLE #

Z-Plex

20

NON-ILLUMINATED SECOND FOCAL PLANE RETICLE

The Z-Plex #20 reticle is known and highly appreciated as a simplistic and highly effective aiming solution. The hunter can easily locate and identify their point of aim and decisively engage the target in most lighting conditions.

INTENDED APPLICATIONS



Predator /
Varmint



Plains Game



Big Game



Long Range



Competition
/ Target
Shooting

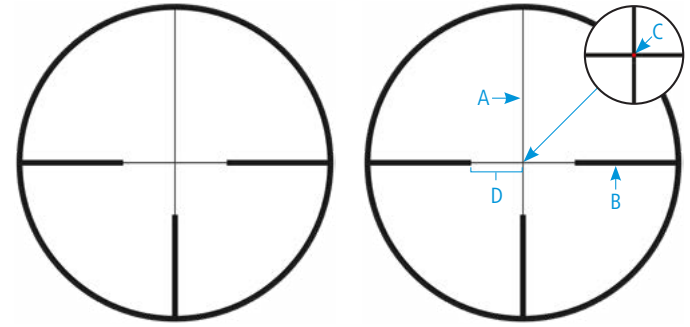

RETICLE TYPE

RETICLE #

Plex-Style with Dot

60

ILLUMINATED SECOND FOCAL PLANE RETICLE

The proven plex-style reticle with a center illuminated red dot is also known for its simplistic design. Even under the most challenging of low-light hunting conditions, the hunter can easily locate and identify their point of aim and decisively engage the target.

INTENDED APPLICATIONS



Predator /
Varmint



Plains Game



Big Game



Long Range



Competition
/ Target
Shooting



RIFLESCOPE(S)	CONQUEST V4 3-12x44	CONQUEST V4 3-12x56	CONQUEST V4 4-16x44
Magnification / Subtension	@ 12x	@ 12x	@ 16x
UNIT OF MEASURE	MOA	MOA	MOA
Line Thickness A	0.17	0.17	0.13
Bar Thickness B	0.95	0.95	0.71
Dot Size C	N/A	N/A	N/A
Opening D	16.6	16.6	12.5

RIFLESCOPE(S)	CONQUEST V4 3-12x56	CONQUEST V4 4-16x44	CONQUEST V4 6-24x50
Magnification / Subtension	@ 12x	@ 16x	@ 24x
UNIT OF MEASURE	MOA	MOA	MOA
Line Thickness A	0.34	0.21	0.14
Bar Thickness B	1.72	1.07	0.72
Dot Size C	0.24	0.24	0.16
Opening D	24.07	15	10

NEW

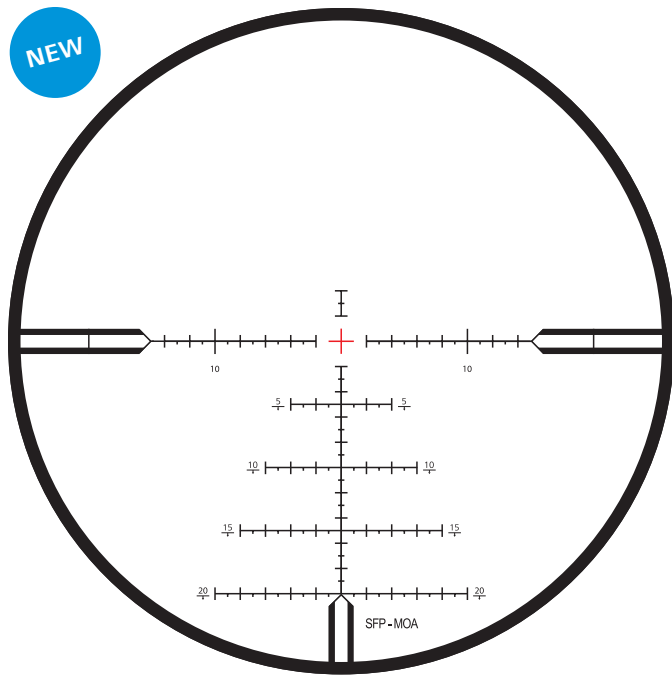

RETICLE TYPE

RETICLE #

ZBi

68

ILLUMINATED SECOND FOCAL PLANE RETICLE

The all-new reticle for 2020 from ZEISS. This reticle was primarily designed for open terrain hunting and long-range hunting. The tree-style reticle is highly intuitive and offers a very refined center point of aim. The 1 minute of angle (MOA) hash marks allow for easy aiming and corrective aiming in windy conditions. Only the center section of the reticle illuminates – providing a most effective and precise point of aim in low-light environmental conditions.

Reticle illustrated above is for the Conquest V4 6-24x50.

INTENDED APPLICATIONS



Predator / Varmint



Plains Game



Big Game



Long Range



Competition / Target Shooting

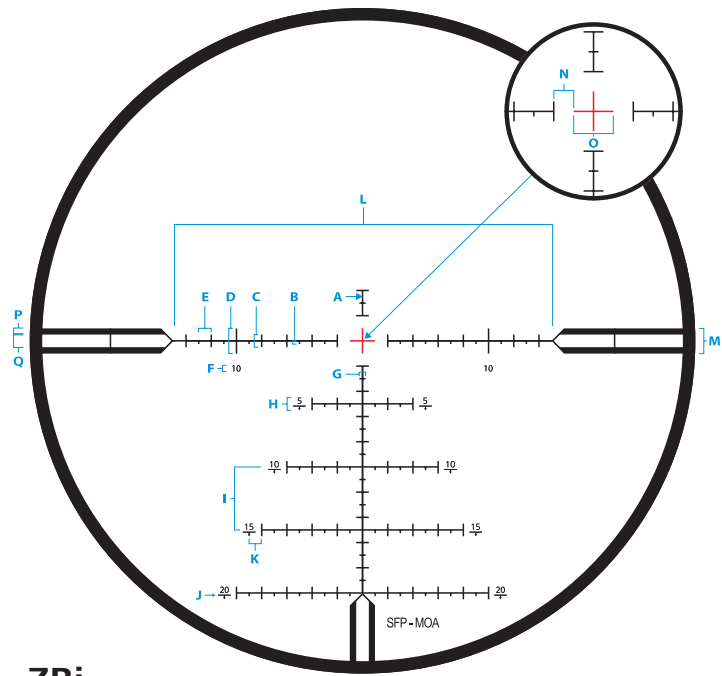

ZBi

RIFLESCOPE(S)	Conquest V4 4-16x44/50	Conquest V4 6-24x50
Magnification / Subtension	@ 16x	@ 24x
UNIT OF MEASURE	MOA	MOA
Line Thickness - A	0.12	0.12
Distance - B	0.25	0.25
Distance - C	1.0	1.0
Distance - D	2.0	2.0
Distance - E	1.0	1.0
Number Height - F	0.5	0.5
Distance - G	0.5	0.5
Drop Indicator Height - H	1.0	1.0
Line Spacing - I	5.0	5.0
Drop Indicator Line Thickness - J	0.06	0.06
Distance to Center of Number - K	1.0	1.0
Distance - L	30	30
Distance - M	2.0	2.0
Spacing Around Center Cross - N	1.0	1.0
Distance - O	2.0	2.0
Distance - P	0.5	0.5
Distance - Q	1.0	1.0

NEW

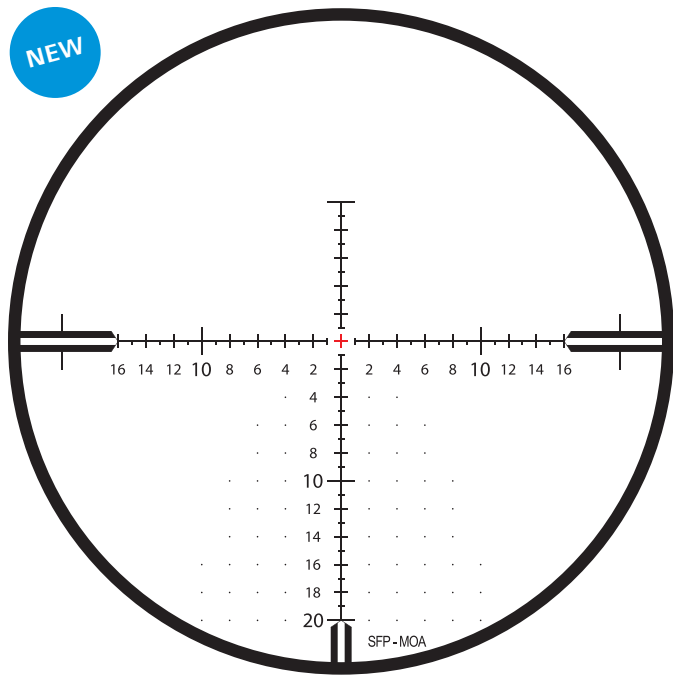

RETICLE TYPE

RETICLE #

ZMOAi-20

89

ILLUMINATED SECOND FOCAL PLANE RETICLE

Another all-new reticle for 2020. This reticle borrows from the most popular reticle design from ZEISS, the ZMOAi-T20; however, it offers a thicker reticle line subtension of 0.12 MOA @ 24x. This makes the reticle easier to see against dark backgrounds, which is especially helpful when hunting against a tree line or aiming at dark game such as black bear, moose, and other game animals hiding in the brush and timber. Aging eyes can also appreciate the benefit of this heavier minute of angle (MOA) reticle design with 1 MOA hash marks. Only the center section of the reticle illuminates – providing a most effective and precise point of aim in low-light environmental conditions.

INTENDED APPLICATIONS



Predator / Varmint



Plains Game



Big Game



Long Range



Competition / Target Shooting

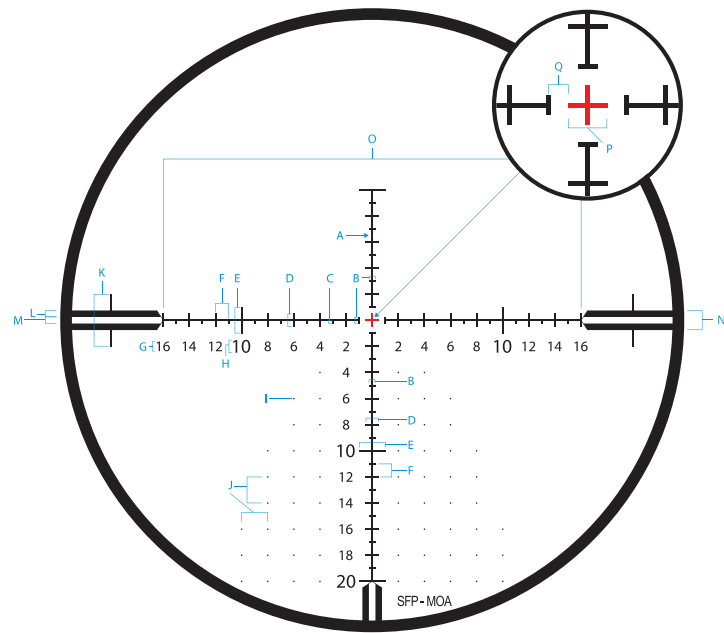

ZMOAi-20

RIFLESCOPE(S)	Conquest V4 6-24x50
Magnification / Subtension	@ 24x
UNIT OF MEASURE	MOA
Line Thickness - A	0.12
Distance - B	0.5
Distance - C	0.25
Distance - D	1.0
Distance - E	2.0
Distance - F	1.0
Standard Number Height - G	0.75
10, 20 Number Height - H	1.0
Dot Size - I	0.12
Dot Spacing - J	2.0
Distance - K	4.0
Distance - L	0.5
Distance - M	0.5
Distance - N	1.5
Distance - O	32
Distance - P	1.0
Spacing Around Center Cross - Q	0.5

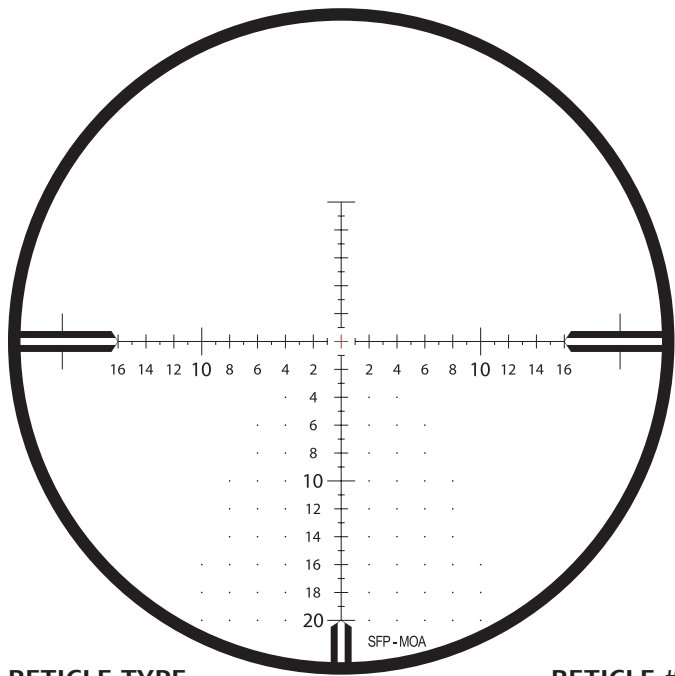

RETICLE TYPE

RETICLE #

ZMOAi-T20

65

ILLUMINATED SECOND FOCAL PLANE RETICLE

Introduced in 2019 – and immediately successful – the ZMOAi-T20 reticle is great for hunting in open terrain or for long-range hunting. Varmint hunters simply love this reticle. It has proven itself time and again as the preferred minute of angle (MOA) reticle for most any shooting application. The windage correction and hold-over dots in the field of view are helpful for shot correction in the wind. The fine line 1 MOA hash marks and floating center point of aim contribute to create the ultimate reticle for the utmost accurate and precision shooting possible. The reticle covers the least amount of target, with a 0.06 MOA line subtension @ 24x, and is highly effective at the longest of ranges. Only the center section of the reticle illuminates – providing a most effective and precise point of aim in low-light environmental conditions.

INTENDED APPLICATIONS



Predator / Varmint



Plains Game



Big Game



Long Range



Competition / Target Shooting

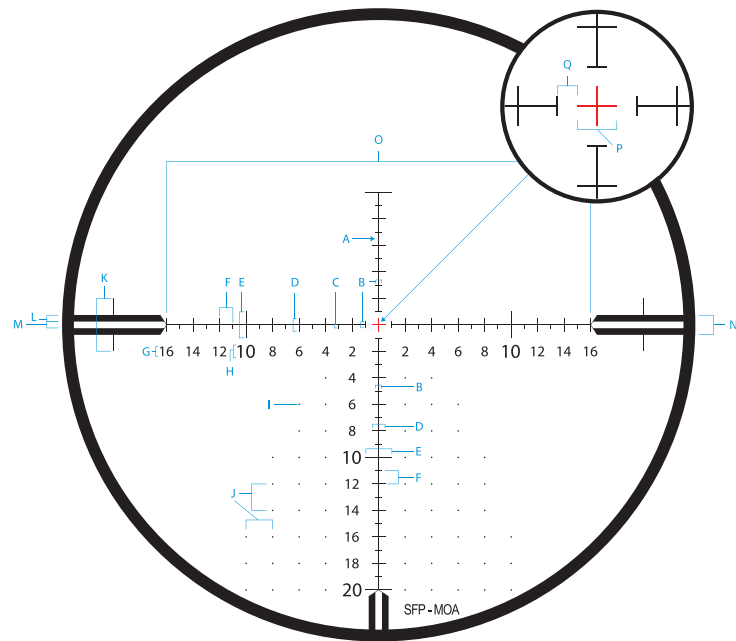

ZMOAi-T20

RIFLESCOPE(S)

Conquest V4 6-24x50

Magnification / Subtension

@ 24x

UNIT OF MEASURE

MOA

Line Thickness - A

0.06

Distance - B

0.5

Distance - C

0.25

Distance - D

1.0

Distance - E

2.0

Distance - F

1.0

Standard Number Height - G

0.75

10, 20 Number Height - H

1.0

Dot Size - I

0.12

Dot Spacing - J

2.0

Distance - K

4.0

Distance - L

0.5

Distance - M

0.5

Distance - N

1.5

Distance - O

32

Distance - P

1.0

Spacing Around Center Cross - Q

0.5

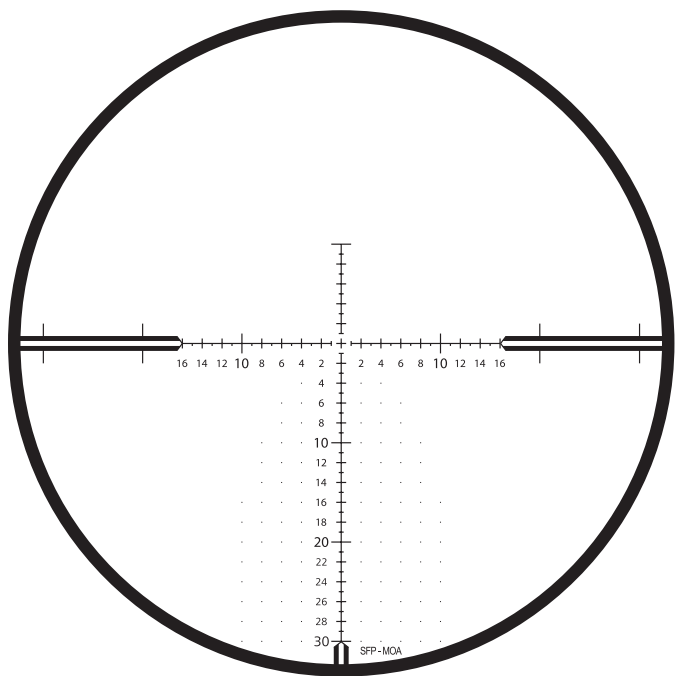

RETICLE TYPE

RETICLE #

ZMOA-T30

64

NON-ILLUMINATED SECOND FOCAL PLANE RETICLE

This reticle was also introduced in 2019. It strikes the perfect balance between a dedicated shooting reticle and hunting reticle. Hunters and shooters alike prefer this option for their do-all riflescope. The minute of angle (MOA) reticle incorporates 1 MOA hash marks, offers 30 MOA of drop below centerline, and has highly useful windage correction and hold-over dots that are properly placed in the field of view for maximum effectiveness and minimal distraction. This is a non-illuminated reticle.

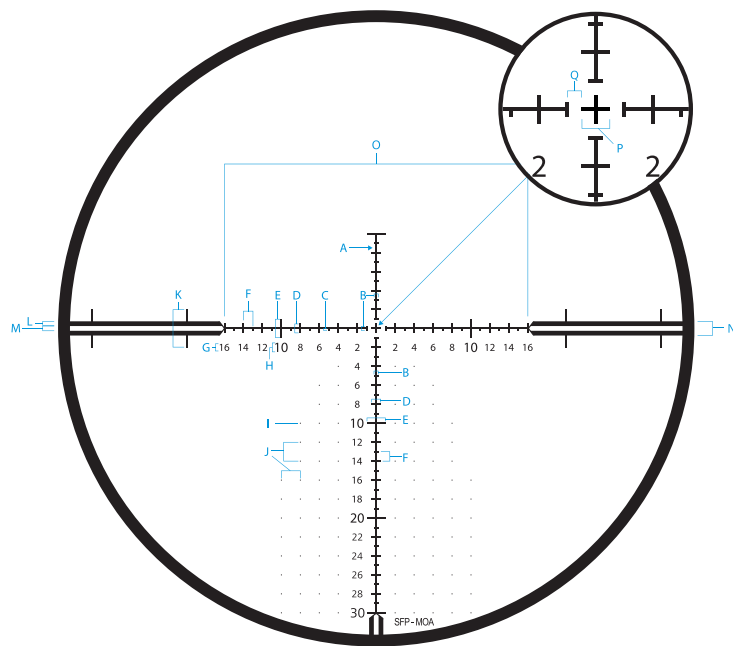

ZMOA-T30

RIFLESCOPE(S)	Conquest V4 4-16x44
Magnification / Subtension	@ 16x
UNIT OF MEASURE	MOA
Line Thickness - A	0.12
Distance - B	0.5
Distance - C	0.25
Distance - D	1.0
Distance - E	2.0
Distance - F	1.0
Standard Number Height - G	0.75
10, 20, 30 Number Height - H	1.0
Dot Size - I	0.12
Dot Spacing - J	2.0
Distance - K	4.0
Distance - L	0.5
Distance - M	0.5
Distance - N	1.5
Distance - O	1.0
Distance - P	1.0
Spacing Around Center Cross - Q	0.5

INTENDED APPLICATIONS



Predator /
Varmint



Plains Game



Big Game



Long Range



Competition
/ Target
Shooting



NEW

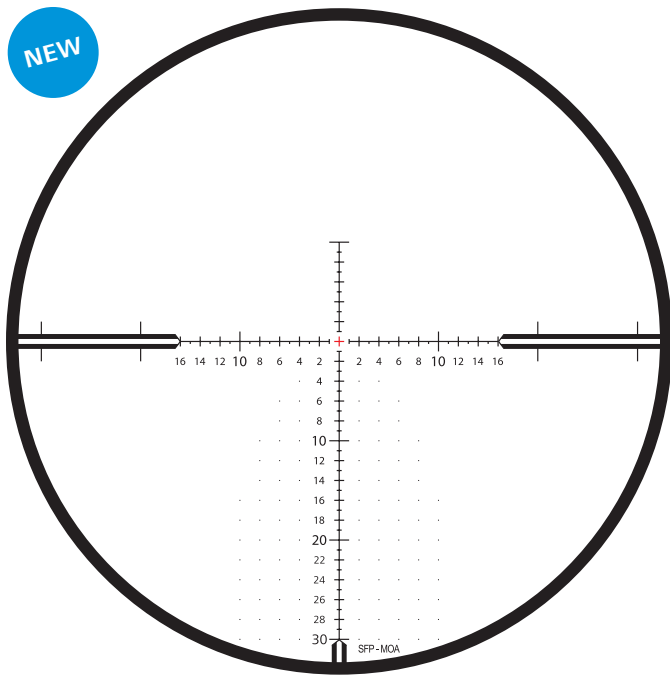

RETICLE TYPE

RETICLE #

ZMOAi-T30

64

ILLUMINATED SECOND FOCAL PLANE RETICLE

New for 2020, the ZMOAi-T30 reticle is the illuminated version of the ZMOA-T30. It also strikes the perfect balance between a dedicated shooting reticle and hunting reticle. Hunters and shooters alike prefer this option for their do-all riflescope. The minute of angle (MOA) reticle incorporates 1 MOA hash marks, offers 30 MOA of drop below centerline, and has highly useful windage correction and hold-over dots that are properly placed in the field of view for maximum effectiveness and minimal distraction. Only the center section of the reticle illuminates – providing a most effective and precise point of aim in low-light environmental conditions.

INTENDED APPLICATIONS



Predator / Varmint



Plains Game



Big Game



Long Range



Competition / Target Shooting

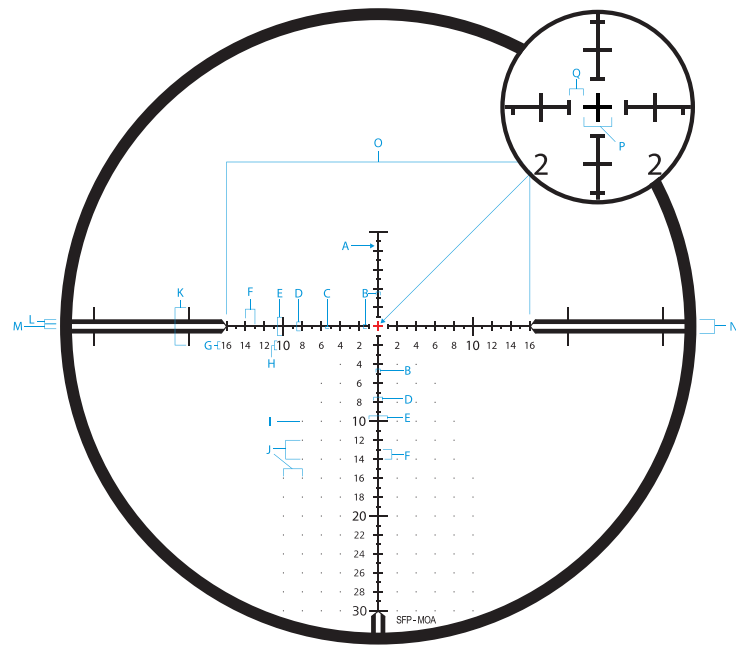

ZMOAi-T30

RIFLESCOPE(S)

Conquest V4 4-16x44 / 50

Magnification / Subtension

@ 16x

UNIT OF MEASURE

MOA

Line Thickness - A

0.12

Distance - B

0.5

Distance - C

0.25

Distance - D

1.0

Distance - E

2.0

Distance - F

1.0

Standard Number Height - G

0.75

10, 20, 30 Number Height - H

1.0

Dot Size - I

0.12

Dot Spacing - J

2.0

Distance - K

4.0

Distance - L

0.5

Distance - M

0.5

Distance - N

1.5

Distance - O

1.0

Distance - P

1.0

Spacing Around Center Cross - Q

0.5

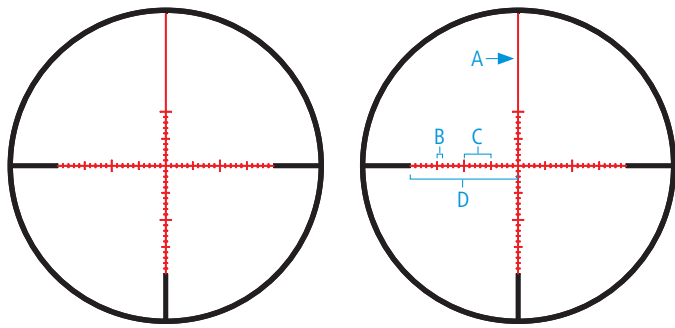

RETICLE TYPE

RETICLE #

ZMOAi-1

93

ILLUMINATED SECOND FOCAL PLANE RETICLE

The ZMOAi-1 reticle offers a simplified and refined effective point of aim. The hash marks are represented in 1 minute of angle (MOA) spacing. The reticle offers a line thickness of 0.14 MOA @ 24x, which makes it easy and fast to pick up in the field of view. The ZMOAi-1 reticle is illuminated.

INTENDED APPLICATIONS



Predator /
Varmint



Plains Game



Big Game



Long Range



Competition
/ Target
Shooting



RIFLESCOPE(S)	CONQUEST V4 4-16x50	CONQUEST V4 6-24x50
Magnification / Subtension	@ 16x	@ 24x
UNIT OF MEASURE	MOA	MOA
Line Thickness A	0.14 @ 16x	0.14 @ 24x
Distance B	1	1
Distance C	5	5
Opening D	20	20

Through-the-Lens Reticle Illustrations

Image below illustrates the ZMOAi-1 reticle from a ZEISS Conquest V4 4-16x50 model set at 4x magnification at 100 yards.



4-Inch Target

Image below illustrates the all-new ZMOAi-20 reticle from a ZEISS Conquest V4 6-24x50 model set at 24x magnification at 350 yards.



10-Inch Target



ZEISS Optics and Benefits



T* (T-Star) Six-layer Coating

For a brighter, clearer and higher-contrast image.



Light Transmission

90% to the eye with ZEISS Conquest V4



Lotutec®

Makes lenses water- and dirt-repellent and easy to clean.



ZEISS Mechanics and Benefits



NEW

External Locking Windage Turret

First-in-class External Locking Windage Turret (ELWT), with windage limiter, makes for easy, super-fast, repeatable, and secure windage adjustments. Pull out to adjust. Push in to lock.



Side Parallax Adjustment and Reticle Illumination Control

Adjustable to ensure absolute best images and most accurate shooting solutions. 10-position rheostat-controlled illumination adjustment.



Ballistic Stop™

An absolute and ultra-positive return to zero – every time. Made of all-metal construction. No plastic. Select your zero, set the Ballistic Stop, and enjoy a lifetime of repeatability.



European-Style Fast Focus Eyepiece

Quick, easy and repeatable diopter adjustment.



Lightweight Design

ZEISS products are engineered with select materials and manufactured to exacting standards to produce a lighter weight sport optic with a focus on precision and repeatability.

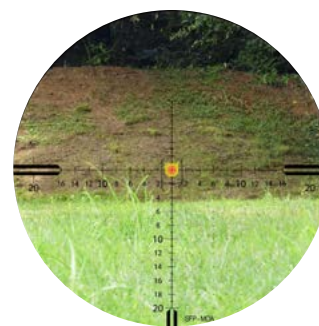

Smart Reticle Designs

Relevant and intuitive reticle designs for today's hunting, long-range hunting, and shooting needs.

ZEISS Conquest V4 Accessories

ZEISS Power Throw Lever

For fast magnification adjustments when speed is a critical factor.



ZEISS Sunshades

Matte Black - Hard Anodized Objectives NEW

This ZEISS Conquest V4 & V6 accessory helps to eliminate harsh glare from the sun while viewing and shooting. Simply install by threading the sunshade to the riflescope's objective.



44 mm

50 mm

56 mm

ZEISS Soft Scope Cover

NEW



ZEISS Precision Rings

NEW

With Integral Anti-Cant Bubble Level

ZEISS ultralight 1913 Mil-Std, STANAG-compliant rings are manufactured to the highest of standards, from premium materials, and with tight tolerances for your long-term safety and field applications. They are designed for optimal long-range shooting solutions and allow for either right- or left-handed operations as well as eye dominance. The bubble level is easily viewed from the shooting position, creating no disturbance in your shooting position. A smarter, sleeker, and ultralightweight ring design for all heavy-duty hunting and shooting applications.

Recoil Lug

Integral bottom recoil lug for best alignment and a secure zero under the harshest recoil

Bubble Level

Integral anti-cant bubble level in top half of ring

Hard Case

Included, with both T15 and T25 Torx® driver bits

Ultralight

Approximately 4.4 oz. with screws (set 30 mm low)

Wider

Offers more clamping surface for a more secure mounting solution for heavy recoiling rifles and heavy riflescopes

Durable Material

7075-T6 aluminum, Mil-Std, Type III, 30-micron hard anodized finish – matte black

Refined Design

Compact and refined design, with low-profile, non-snagging hardware Type 303 stainless steel top cap screws – with black oxide finish Micro-radiused on all machined leading edges to ensure a non-marring design

Ring height measurements are determined from top of mounting rail to center line of ring's bore.



Image displayed is a 30 mm medium-height ring.

Sizes available: 30 mm, 34 mm, 36 mm in various heights.

ZEISS Conquest V4 Riflescopes

Part Numbers

3-12x44 Elev. Adj. 70 MOA		
PART NUMBER	RETICLE	RETAIL
522961 9920 000	Plex #20	\$699.99
Capped Elev. Turret - Capped Wind. - .25 MOA – Fixed Parallax		
3-12x56 Elev. Adj. 70 MOA		
PART NUMBER	RETICLE	RETAIL
522921 9920 000	Plex #20	\$899.99
Capped Elev. Turret - Capped Wind. - .25 MOA - Fixed Parallax		
522925 9960 000	Plex Illum. #60	\$999.99
Capped Elev. Turret - Capped Wind. - .25 MOA - Fixed Parallax		
4-16x44 Elev. Adj. 80 MOA		
PART NUMBER	RETICLE	RETAIL
522931 9920 080	Z-Plex #20	\$949.99
Ext. Elev. Turret - Ballistic Stop - Capped Wind. - .25 MOA - Parallax Adj.		
522931 9964 080	ZMOAi-T30 #64	\$999.99
Ext. Elev. Turret - Ballistic Stop - Capped Wind. - .25 MOA - Parallax Adj.		
522935 9960 000	Plex Illum. #60	\$1,049.99
Capped Elev. Turret - Capped Wind. - .25 MOA - Parallax Adj.		
522935 9960 080	Plex Illum #60	\$1,099.99
Ext. Elev. Turret - Ballistic Stop - Capped Wind. - .25 MOA - Parallax Adj.		
522935 9964 080	ZMOAi-T30 Illum. #64	\$1,099.99
Ext. Elev. Turret - Ballistic Stop - Capped Wind. - .25 MOA - Parallax Adj.		
522935 9964 090	ZMOAi-T30 Illum. #64	\$1,149.99
Ext. Elev. Turret - Ballistic Stop - Ext. Locking Wind. - .25 MOA - Parallax Adj.		
522935 9968 000	ZBi Illum #68	\$1,049.99
Capped Elev. Turret - Capped Wind. - .25 MOA - Parallax Adj.		
522935 9968 080	ZBi Illum #68	\$1,099.99
Ext. Elev. Turret - Ballistic Stop - Capped Wind. - .25 MOA - Parallax Adj.		
522935 9968 090	ZBi Illum #68	\$1,149.99
Ext. Elev. Turret - Ballistic Stop - Ext. Locking Wind. - .25 MOA - Parallax Adj.		
4-16x50 Elev. Adj. 80 MOA		
PART NUMBER	RETICLE	RETAIL
522945 9964 080	ZMOAi-T30 Illum. #64	\$1,099.99
Ext. Elev. Turret - Ballistic Stop - Capped Wind. - .25 MOA - Parallax Adj.		
522945 9964 090	ZMOAi-T30 Illum. #64	\$1,149.99
Ext. Elev. Turret - Ballistic Stop - Ext. Locking Wind. - .25 MOA - Parallax Adj.		
522945 9968 080	ZBi Illum #68	\$1,099.99
Ext. Elev. Turret - Ballistic Stop - Capped Wind. - .25 MOA - Parallax Adj.		
522945 9993 080	ZMOAi-1 Illum. #93	\$1,099.99
Ext. Elev. Turret - Ballistic Stop - Capped Wind. - .25 MOA - Parallax Adj.		
6-24x50 Elev. Adj. 80 MOA		
PART NUMBER	RETICLE	RETAIL
522955 9960 080	Plex Illum. #60	\$1,199.99
Ext. Elev. Turret - Ballistic Stop - Capped Wind. - .25 MOA - Parallax Adj.		

522955 9965 080	ZMOAi-T20 Illum. #65	\$1,199.99
Ext. Elev. Turret - Ballistic Stop - .Capped Wind. - .25 MOA - Parallax Adj.		
522955 9965 090	ZMOAi-T20 Illum. #65	\$1,249.99
Ext. Elev. - Ballistic Stop - Ext. Locking Wind. - .25 MOA - Parallax Adj.		
522955 9968 090	ZBi Illum #68	\$1,249.99
Ext. Elev. - Ballistic Stop - Ext. Locking Wind. - .25 MOA - Parallax Adj.		
522955 9989 090	ZMOAi-T20 Illum. #89	\$1,249.99
Ext. Elev. - Ballistic Stop - Ext. Locking Wind. - .25 MOA - Parallax Adj.		
522955 9993 080	ZMOAi-1 Illum. #93	\$1,199.99
Ext. Elev. Turret - Ballistic Stop - Capped Wind. - .25 MOA - Parallax Adj.		

Accessories

ZEISS Precision Rings		
PART NUMBER	MODEL	RETAIL
2309 905	30 mm - LOW (.850 in. / 21.6 mm)	\$179.99
2309 906	30 mm - MEDIUM (1.0 in. / 25.4 mm)	\$179.99
2309 907	30 mm - HIGH (1.18 in. / 30 mm)	\$179.99
2345 660	30 mm - X-HIGH (1.375 in. / 34.9 mm)	\$179.99
2345 661	30 mm - XX-HIGH (1.5 in. / 38.1 mm)	\$179.99
2345 663	34 mm - LOW (1.0 in. / 25.4 mm)	\$199.99
2345 664	34 mm - MED (1.125 in. / 28.5 mm)	\$199.99
2345 665	34 mm - HIGH (1.375 in. / 34.9 mm)	\$199.99
2345 666	34 mm - X-HIGH (1.5 in. / 38.1 mm)	\$199.99
2309 918	36 mm - MEDIUM (1.06 in. / 27 mm)	\$199.99
2309 919	36 mm - HIGH (1.22 in. / 31 mm)	\$199.99
Conquest V4 Magnification Throw Lever		
PART NUMBER	MODEL	RETAIL
2248 168	Conquest V4	\$79.99
ZEISS Sunshades – 3-inch, matte black, thread-on		
PART NUMBER	MODEL	RETAIL
529860 0001	44 mm	\$39.99
529860 0002	50 mm	\$39.99
529860 0003	56 mm	\$39.99
Soft Scope Covers – Neoprene black with ZEISS logo		
PART NUMBER	MODEL	RETAIL
2231 631	Soft Rifle Scope Cover – Small	\$29.99
2231 632	Soft Rifle Scope Cover – Medium	\$29.99
2231 633	Soft Rifle Scope Cover – Large	\$29.99
2231 634	Soft Rifle Scope Cover – X-Large	\$29.99

ZEISS Conquest V4 Riflescopes

Specifications

Model	3 – 12 × 44	3 – 12 × 56
Magnification	3 x – 12 x	3 x – 12 x
Focal Plane	Second	Second
Effective Lens Diameter	27.1 mm – 44 mm	27.7 mm – 56 mm
Exit Pupil Diameter	8.9 mm – 3.7 mm	9.2 mm – 4.7 mm
Twilight Factor	9.0 – 23.0	9.1 – 25.9
Field of View at 100 yds	38 ft – 9.5 ft	38 ft – 9.6 ft
Angular Field of View, Real	7.24° – 1.81°	7.3° – 1.8°
Diopter Range	- 3 / + 2 dpt	
Eye Relief	3.5 in	
Parallax Setting	100 yds	100 yds
Elevation Adjustment Range	70 MOA	70 MOA
Windage Adjustment Range	70 MOA	70 MOA
Click Value	0.25 MOA	
Main Tube Diameter	30 mm	
Eyepiece Tube Diameter	44 mm	
Objective Tube Diameter	50 mm	62 mm
Coating	LotuTec® / ZEISS T*	
Fogproof	Nitrogen Purged	
Waterproof	400 mbar (submerged 13 ft for 2 hours)	
Operating Temperature	-4 / +131°F	
Length	13.8 in	14.5 in
Weight / with Illumination	17.9 oz	20.9 oz / 21.8 oz
Weight with ELWT	N/A	N/A
Reticles	#20 Z-Plex	#20 Z-Plex #60 illum.

*Dependent upon riflescope configuration and part number.

	4 – 16 × 44	4 – 16 × 50	6 – 24 × 50
	4 x – 16 x	4 x – 16 x	6 x – 24 x
	Second	Second	Second
	33.2 mm – 44 mm	34.5 mm – 50 mm	44.9 mm – 50 mm
	8.5 mm – 2.8 mm	8.5 mm – 3.1 mm	7.5 mm – 2.1 mm
	11.5 – 26.5	11.7 – 28.3	16.4 – 34.6
	28.5 ft – 7.1 ft	28.5 ft – 7.1 ft	19 ft – 4.8 ft
	5.4° – 1.4°	5.43° – 1.36°	3.6° – 0.9°
	- 3 / + 2 dpt		
	3.5 in		
	10 yds – ∞ or 50 yds – ∞*	10 yds – ∞ or 50 yds – ∞*	10 yds – ∞ or 50 yds – ∞*
	80 MOA	80 MOA	80 MOA
	60 MOA	60 MOA	60 MOA
	0.25 MOA		
	30 mm		
	44 mm		
	50 mm	56 mm	56 mm
	LotuTec® / ZEISS T*		
	Nitrogen Purged		
	400 mbar (submerged 13 ft for 2 hours)		
	-4 / +131°F		
	14 in	14.5 in	14.5 in
	21.3 oz	23 oz	22.5 oz / 23 oz
	22.93 oz	24.13 oz	24.13 oz
	#20 Z-Plex #60 illum. ZMOA-T30 ZBi illum. ZMOA-T30 illum.	ZMOAi-1 illum. ZBi illum. ZMOAi-T30 illum.	#60 illum. ZMOAi-1 illum. ZMOAi-T20 illum. ZMOAi-20 illum. ZBi illum.

ZEISS is not responsible for typographical errors. Specifications and products may change without prior written notice. All efforts have been made to make sure content is accurate at time of printing.

ZEISS Limited Lifetime Transferable Warranty and Five-Year No-Fault Policy

Your ZEISS Sports Optics Optical System is warranted against defects in workmanship and materials for the life of the Product. Electronic components are warranted against defects in workmanship and materials for five years from the original date of manufacture or purchase. Non-optical system components and accessories are warranted against defects in workmanship and materials for one year from the date of manufacture or purchase. If a defect that is covered by this Warranty is found, ZEISS will, at its option, either repair or replace the Product with a new or reconditioned ZEISS product of comparable specifications.

Every product we make is backed by an industry leading, limited lifetime, transferable warranty. In addition to this warranty, ZEISS offers a Five-Year No-Fault Policy on select Victory and Conquest products. During the first five years of original ownership, ZEISS will, at its discretion, repair or replace your product if it is accidentally damaged during normal and intended use.

To view the Limited Lifetime Warranty and No-Fault Policy, please visit:
zeiss.com/consumer-products/us/service

Join the **ZEISS Hunting Community**.
Follow us online:



facebook.com/ZEISSHuntingUS



youtube.com/user/zeissportsoptics



[@ZEISSHunting](https://instagram.com/ZEISSHunting)

Customer Service

1-800-441-3005

info.sportsoptics.us@zeiss.com

Carl Zeiss SBE, LLC

Consumer Products

zeiss.com/consumer-products/us/hunting

Consumer Pamphlet - Printed in USA 05/2020

Carl Zeiss SBE, LLC is not responsible for typographical errors, and we make every effort to ensure the accuracy of the information at time of printing. Products and specifications are subject to change without notice.

Visit zeiss.com/consumer-products/us/hunting
for the most up-to-date product information.



Seeing beyond